

DISPOSABLE PRODUCTS

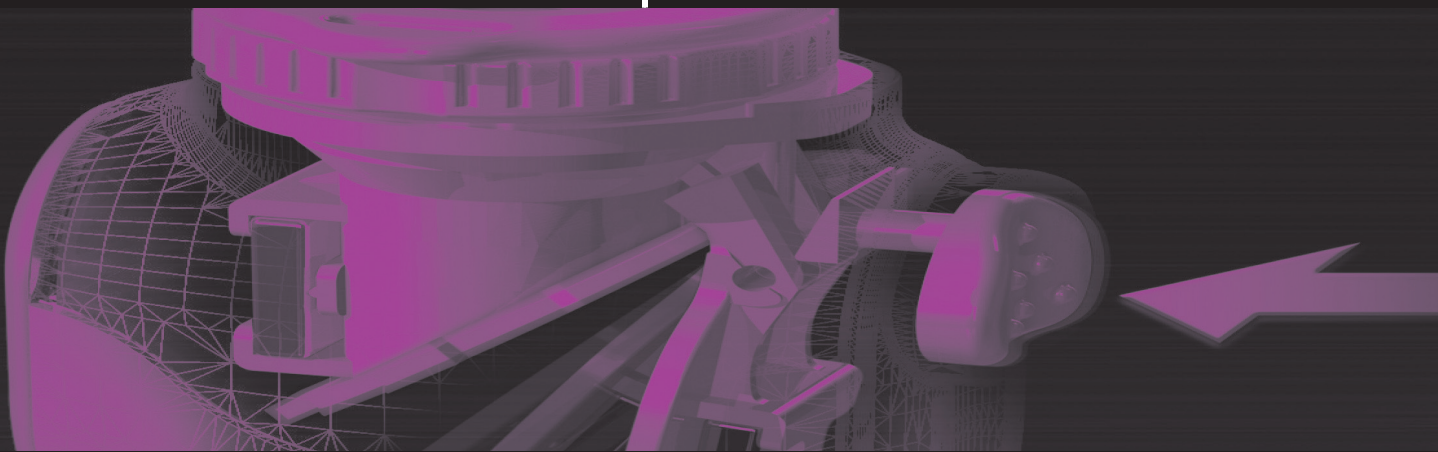

www.mgb-berlin.de

MGB

CONTENT

■ LapBags and Verres Needles	<i>Page 3</i>
■ Laport-U, Disposable Universal Trocar System	<i>Page 4-5</i>
■ Laport-U, Disposable Trocar System	<i>Page 6-7</i>
■ Laport Optical	<i>Page 8-9</i>
■ Laport Hasson	<i>Page 10</i>
■ SLS Titan Clips	<i>Page 11</i>
■ Disposable Laparoscopic Instruments	<i>Page 12-14</i>
■ Disposable Electrosurgical Pencil	<i>Page 14</i>
■ Disposable Overmould Electrode	<i>Page 15</i>
■ Skin Stapler & Remover	<i>Page 16</i>
■ Ground Pads and Cables	<i>Page 17-19</i>

DISPOSABLES

LAPBAGS AND VERRES NEEDLE

Products

Order-No.

Description



420-01010
(Size XL/190 x 210 mm)

420-01020
(Size L/160 x 180 mm)

420-01030
(Size M/120 x 135 mm)

LapBag

- MGB's LapBag is a highend retrievable system
- Automatically opened by preloaded spring
- Transparent and ultimate-strength bag-materiel
- For use with a minimum Ø 10 mm trocar sleeve
- Easy handling

- Sterile
- 10 pcs./box

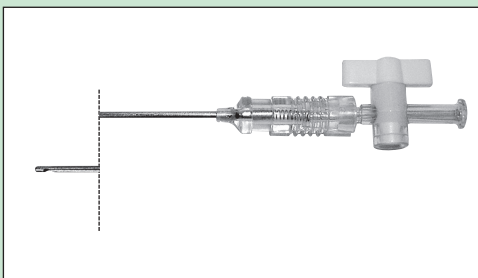

420-02010

420-02020

Verres Needle

- Luer stopcock
- Working length: 120 mm
- Working length: 150 mm

- Sterile
- 25 pcs./box



420-01200

TV Camera Drape

- 13 x 250 cm

- Sterile
- 100 pcs./box



675-11200

Filter

- For insufflator
- Conus 15 mm

- 50 pcs./box

DISPOSABLES

Laport®-U UNIVERSAL TROCAR SYSTEM



New Features

- Universal seal allows passage of instruments of a wide range
- Highly elastic fibres
- Excellent restorative capacity
- Minimized friction

What else?

- Transparent sleeve and trocar housing
- Automatic flap-valve
- Flap-valve activated by the instrument or manually by pushing a button
- Ergonomic trocar housing with improved weight-balance
- Extremely fast responding safety shield-system
- Simple blade activation-system
- Optimised dilating obturator design
- Available in sets or as stand-alone

- No need for a reducer anymore
- Enhanced performance during surgery
- This saves time & money



Laport 11

New Laport-U 5/11

DISPOSABLES

Laport® -U UNIVERSAL TROCAR SYSTEM

Products

Order-No.

Description



420-05111

Laport-U disposable Trocar-Set

- Universal trocar sleeve and safety shielded trocar

420-05211

- Universal trocar sleeve and safety dilating trocar

420-05311

- Universal trocar sleeve

Ø 5 mm - Ø 11 mm

- 10 pcs./box
- Working length: 100 mm



420-05112

Laport-U disposable Trocar-Set

- Universal trocar sleeve and safety shielded trocar

420-05212

- Universal trocar sleeve and safety dilating trocar

420-05312

- Universal trocar sleeve

Ø 5 mm - Ø 12 mm

- 10 pcs./box
- Working length: 100 mm

DISPOSABLES

Laport® DISPOSABLE TROCAR SYSTEM

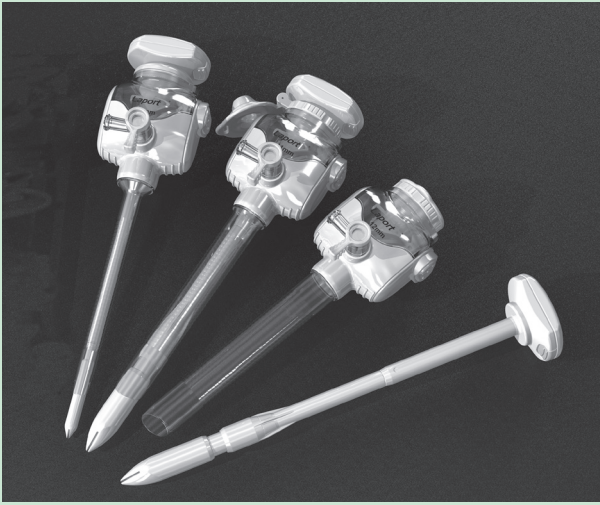

Established Design

- Transparent sleeve and transparent trocar housing
- Magnetic flap-valve
- Flap-valve activated by the instrument or manually by pressing a button
- Ergonomic trocar-housing with better weight-balance
- Fixed and 360° rotatable reducer for sleeve-diameter 10mm/11mm, 12 mm
- New and extremely fast responding safety shield-system
- New designed dilating obturator
- In combination with the approved benefits of the former version (like threaded integrated sleeve, availability in set's etc.), you will be able to compete successfully in the "premium market" of disposable access instrumentation



1

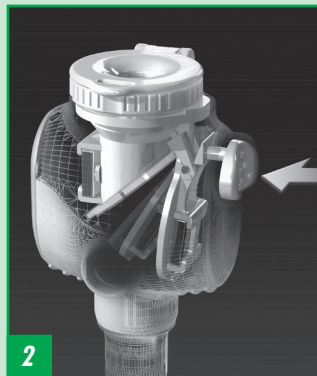

2



3

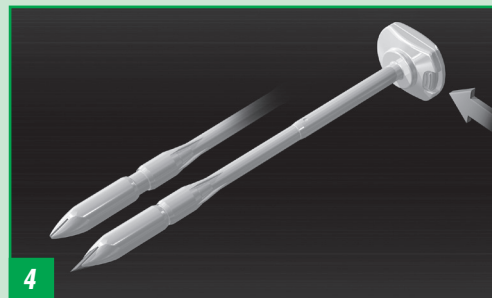

4

1 Rotating Reducer Cap:

It has a reducer cap, which can be rotated 360°, for comfortable performance of surgical procedures.

2 One Touch Valve Control:

A valve, which is driven by a button, allows sealing of the system. Its activation is useful for intra-abdominal gauze or specimen retrieval. It can be activated with a single hand. A stopcock for gas insufflation is included.

3 No Fear for reducer Cap Loss:

The reducer cap is connected to the main body of trocar through a hinge, thus risk of reducer cap loss or contamination is eliminated.

4 Simple Blade Activation System:

The obturator has a safety button which activates a retractile internal cutting knife. It is only activated during trocar insertion maneuver.

DISPOSABLES

Laport® DISPOSABLE TROCAR SYSTEM

Products

Order-No.

Description

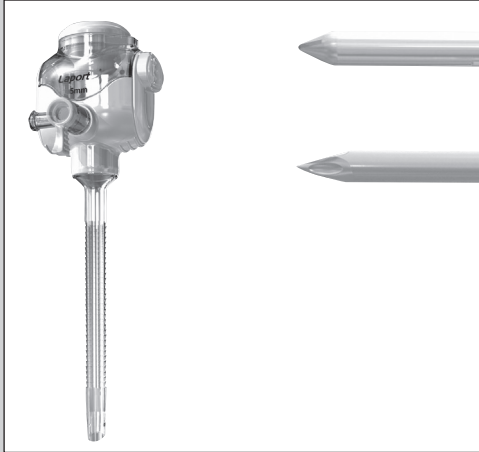

420-04105 (100 mm)
420-04105/75 (75 mm)

Laport Disposable Trocar-Set

- Trocar sleeve and safety shielded trocar

420-04205 (100 mm)
420-04205/75 (75 mm)

- Trocar sleeve and dilating trocar

420-04305 (100 mm)
420-04305/75 (75 mm)

- Disposable trocar sleeve

Ø 5 mm

- 10 pcs./box
- Working length: 100 mm/75 mm

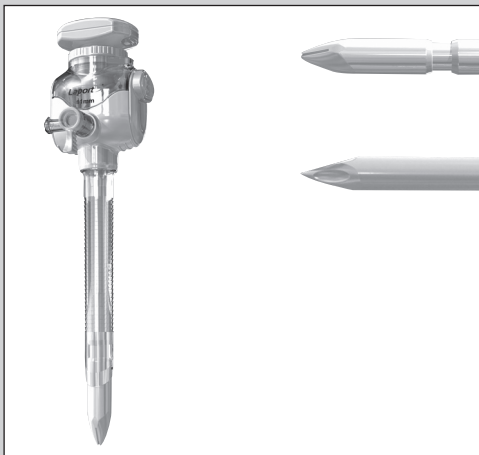

420-04111

Laport Disposable Trocar-Set

- Trocar sleeve and safety shielded trocar

420-04211

- Trocar sleeve and dilating trocar

420-04311

- Disposable trocar sleeve

Ø 10/11 mm

- 10 pcs./box
- incl. reducer for Ø 5 mm instruments
- Working length: 100 mm

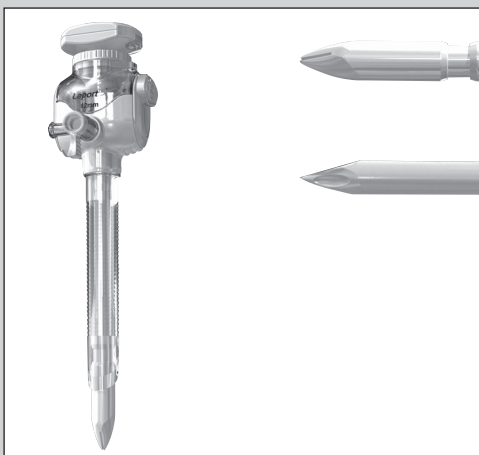

420-04112

Laport Disposable Trocar-Set

- Trocar sleeve and safety shielded trocar

420-04212

- Trocar sleeve and dilating trocar

420-04312

- Disposable trocar sleeve

Ø 12 mm

- 10 pcs./box
- incl. reducer for Ø 5 mm instruments
- Working length: 100 mm

DISPOSABLES

Laport® LAPORT OPTICAL

Products

Order-No.

Description



420-06111

*Trocar sleeve and
optical dilating trocar*

Ø 11 mm

- 10 pcs./box
- Working length: 150 mm



420-06112

*Universal trocar sleeve
and optical dilating trocar*



420-06211

*Trocar sleeve and
optical dilating trocar*

Ø 12 mm

- 10 pcs./box
- Working length: 150 mm



420-06212

*Universal trocar sleeve
and optical dilating trocar*

DISPOSABLES

Laport® LAPORT OPTICAL

Products

Order-No.

Description



420-06311

Trocar sleeve and optical dilating trocar



420-06312

Universal trocar sleeve and optical dilating trocar

Ø 12 mm

- 10 pcs./box
- Working length: 103 mm



Idea

Allow entry into the abdominal cavity under direct vision



Advantages

- Enable visualization of tissue layers during insertion
- Risk of tearing or lacerating blood vessels or bowel is largely excluded

DISPOSABLES

Laport® LAPORT HASSON



Products

Order-No.

Description

Ø 12 mm



420-07111

Trocar sleeve and blunt dilating trocar incl. Hasson cone

■ 10 pcs./box



420-07211

Universal trocar sleeve and blunt dilating trocar incl. Hasson cone

SLS TITAN CLIPS

Products

Order-No.

Description



429-70381

SLS Titan **LARGE**

■ Box with 20 cartridges of 6 clips



429-70379

SLS Titan Clip **MEDIUM-LARGE**

■ Box with 20 cartridges of 6 clips

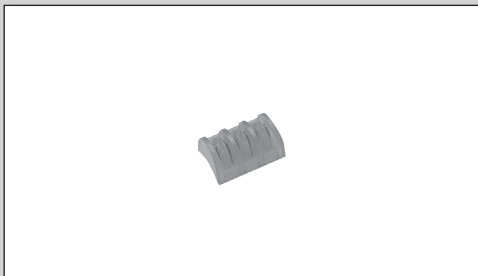

429-70389

SLS Titan Clip **MEDIUM**

■ Box with 30 cartridges of 6 clips

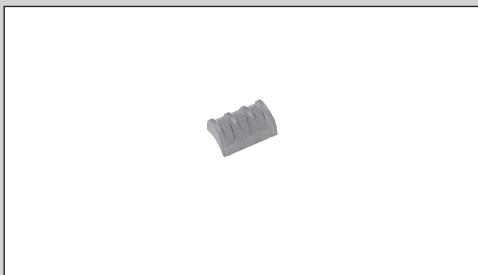

429-70392

SLS Titan Clip **SMALL-MEDIUM**

■ Box with 30 cartridges of 6 clips

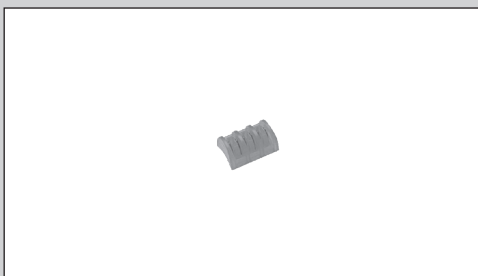

429-70388

SLS Titan Clip **SMALL**

■ Box with 30 cartridges of 6 clips

1 Pure Titanium:

Pure titanium annealed to a malleable consistency providing maximum vessel occlusion and zero memory to prevent tip opening after application. Biologically inert, radiolucent and non magnetic for use with MRI or related scanning equipment.

2 Chevron Shape:

Chevron shape provides progressive and encompassing tip to tip closure before complete and secure occlusion of tissue or vessel.

3 Diamond Shape Grooving:

Diamond grooving and interlocking atraumatic teeth design of the clip ensures enhanced security in vessel closure: striation is composed of small pyramidal heads, similar to tungsten inserts from needle-holders, insuring a firm multi-directional non hurting vessel grip.

DISPOSABLES

DISPOSABLE LAPAROSCOPIC INSTRUMENTS

Products

Order-No.

Description



L 09 S-330/2

Straight Scissor

- Double action
- Working length: 330 mm

■ 10 pcs./box



L 09 C-330/2

Curved Scissor

- Double action
- Working length: 330 mm

■ 10 pcs./box

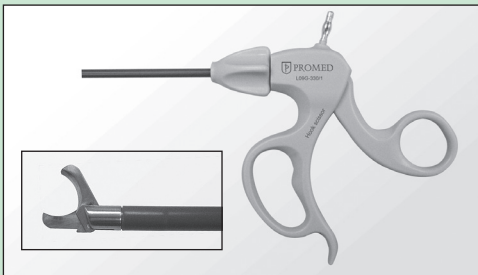

L 09 G-330/1

Hook Scissor

- Single action
- Working length: 330 mm

■ 10 pcs./box

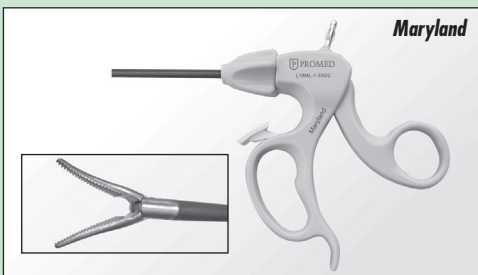

L 18 ML-1-330/2

Dissecting Forceps

- Double action
- With ratchet
- Working length: 330 mm

■ 10 pcs./box



L 18 ML-0-330/2

Dissecting Forceps

- Double action
- Without ratchet
- Working length: 330 mm

■ 10 pcs./box

DISPOSABLE LAPAROSCOPIC INSTRUMENTS

Products

Order-No.

Description



L 05-330/2

Biopsy Forceps

- Double action
- Working length: 330 mm

■ 10 pcs./box

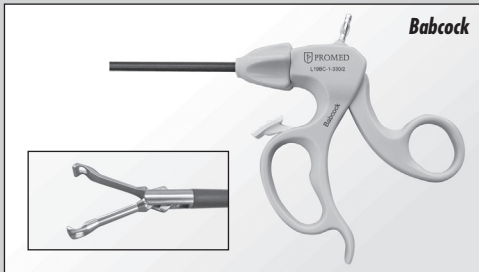

L 19 BC-1-330/2

Grasping Forceps

- Double action
- With ratchet
- Working length: 330 mm

■ 10 pcs./box

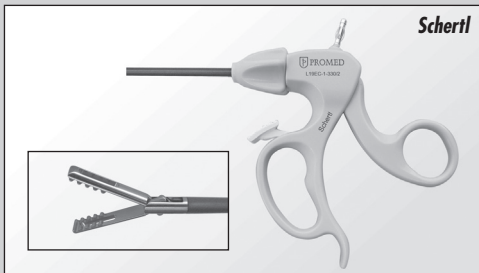

L 19 EC-1-330/2

Grasping Forceps

- Double action
- With ratchet
- Working length: 330 mm

■ 10 pcs./box

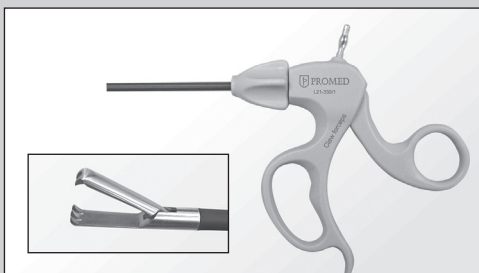

L 21-330/1

Claw Forceps

- Double action
- Working length: 330 mm

■ 10 pcs./box

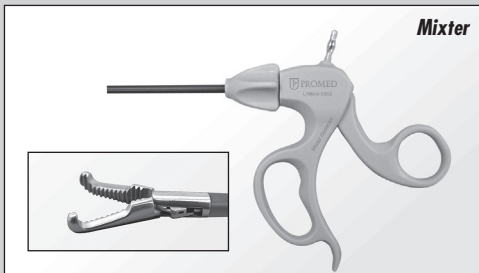

L 18 M-0-330/2

Dissecting Forceps

- Double action
- Working length: 330 mm

■ 10 pcs./box

DISPOSABLES

DISPOSABLE LAPAROSCOPIC INSTRUMENTS

Products

Order-No.

Description



L 18 DB-1-330/2

Dissecting and Grasping Forceps

- Double action
- With ratchet
- Working length: 330 mm

■ 10 pcs./box

DISPOSABLE ELECTROSURGICAL PENCIL

Products

Order-No.

Description



PD 513

PD 513 P5

Push Button Pencil

- W/stamping blade
- Cable length: 3 m
- Cable length: 5 m

For all Electrodes:

■ 10 pcs./box

DISPOSABLE OVERMOULD ELECTRODE

Products

Order-No.

Description

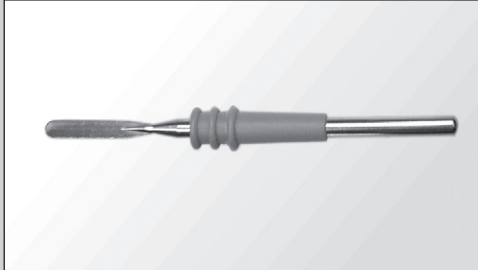

EB 22 M2

Standard Blade

- Overmould
- Working length: 69 mm

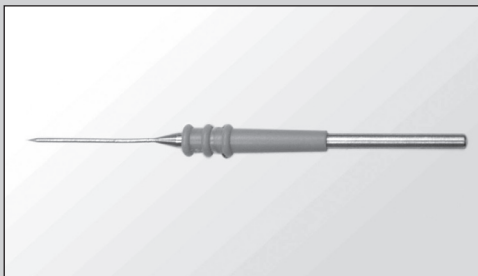

EN 22 M2

Standard Needle

- Overmould
- Working length: 69 mm

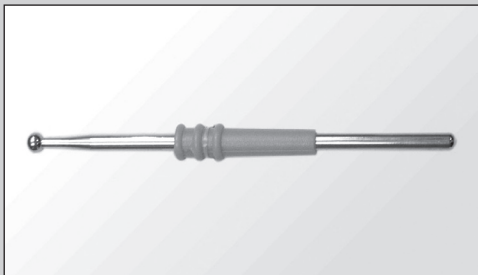

ES 22 M3

Standard 3 mm Ball

- Overmould
- Working length: 69 mm

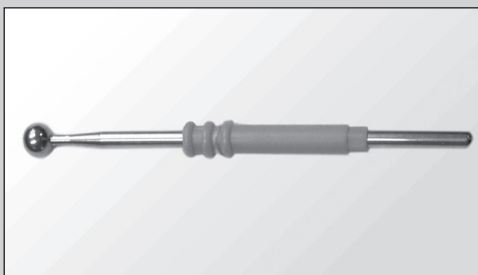

ES 22 M4

Standard 5 mm Ball

- Overmould
- Working length: 71 mm

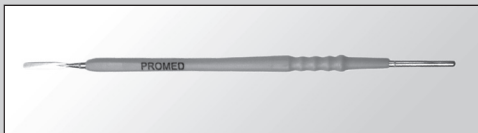

EB 26 M2

Extended Blade

- Overmould

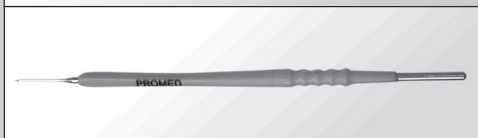

EN 26 M2

Extended Needle

- Overmould

DISPOSABLES

DISPOSABLE SKIN STAPLER & REMOVER

Products

Order-No.

Description



SP 35 R1

Disposable Skin Stapler

■ Regular type

■ 6 pcs./box



SP 35 W1

Disposable Skin Stapler

■ Regular type

■ 6 pcs./box



SR 00 D1

Disposable Skin Stapler Remover

10 pcs./box

GROUND PADS

Products

Order-No.

Description

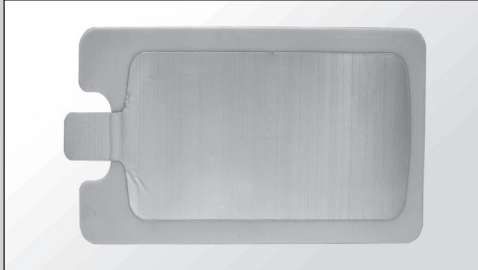

GM 100

Pediatric Monopolar

- Vertical
- Non split surface
- Conductive area: 75 cm²

■ 25 pcs./box

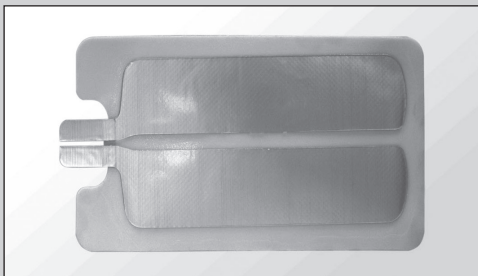

GB 100

Pediatric Bipolar

- Vertical
- Split surface
- Conductive area: 66 cm²

■ 25 pcs./box

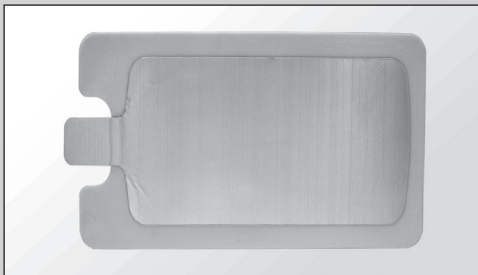

GM 900

Adult Monopolar

- Vertical
- Adult, non split surface
- Conductive area: 132 cm²

■ 25 pcs./box

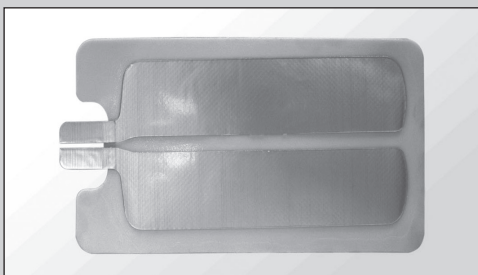

GB 900

Adult Bipolar

- Vertical
- Adult, split surface
- Conductive area: 119 cm²

■ 25 pcs./box

DISPOSABLES

DETACHABLE GROUND PAD CABLES

Products

Order-No.

Description



GC 2VN

ValleyLab Non-Rem Type

- Cable length: 3m
- Plug type: ValleyLab non-rem plug
- Safety lock system
- PE Bag and Label

■ 50 pcs./box



GC 2VR

ValleyLab Rem Type

- Cable length: 3m
- Plug type: ValleyLab rem plug
- Safety lock system
- PE Bag and Label

■ 50 pcs./box

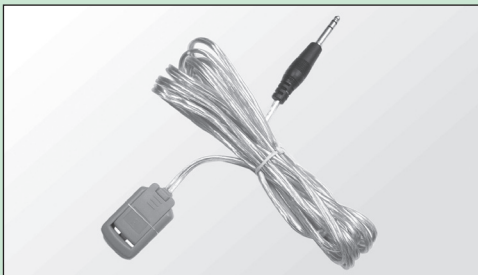

GC 2HF6

6.3 mm Hi-Fi Plug

- Cable length: 3m
- Plug type: 6.3 mm Hi-Fi plug
- Safety lock system
- PE Bag and Label

■ 50 pcs./box



GC 2HF5

5.3 mm Hi-Fi-Plug

- Cable length: 3m
- Plug type: 5.3 mm Hi-Fi plug
- Safety lock system
- PE Bag and Label

■ 50 pcs./box

MGB BERLIN

YOUR PARTNER IN ENDOSCOPY AND COMPLETE SYSTEMS FOR THE MINIMAL INVASIVE SURGERY

*ENT – Laryngoscopy, Bronchoscopy,
Otoscopy, Sinoscopy*

Endoscopy Surgery – Laparoscopy

Urology – Resectoscopy – Cystoscopy

Gynaecology – Hysteroscopy – Resectoscopy

Arthroscopy – Shaver System

Electronic Devices for all Applications

- | | |
|--------------------|----------------------------|
| ■ Video Cameras | ■ Monitors |
| ■ Light-Sources | ■ Disto II Digital Storage |
| ■ Gas-Insufflators | ■ Shaver |
| ■ Pumps | ■ RF-Surgical Device |



MGB Endoskopische Geräte GmbH Berlin

Schwarzschildstrasse 6 · 12489 Berlin

Phone: +49 - 30 - 6392 - 7000

Fax: +49 - 30 - 6392 - 7011

E-mail: sales@mgb-berlin.de

Internet: www.mgb-berlin.de

